

ORECK[®] XL[®]

SIMPLY AMAZING[®]



USA: 1-800-989-3535
CANADA: 1-888-676-7325



WWW.ORECK.COM



VISIT ONE OF OUR OVER
450 STORE LOCATIONS



USER'S GUIDE
XL21
LOANER VAC
XL21-700LOANER

HIGH SPEED UPRIGHT VACUUM WITH

**HEPA
CELOC[®]**

HYPO-ALLERGENIC FILTERING SYSTEM

Antimicrobial Protection

Microban[®]
antimicrobial product protection

Inhibits the growth of odor-causing bacteria,
mold and mildew on the bag

• IMPORTANT •
SAVE THIS BOOKLET!

Includes:

- Safety Warnings
- Warranty
- Operating Instructions
- Trouble Diagnosis
- Accessories

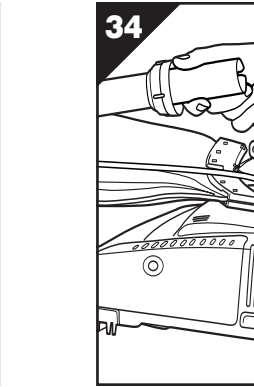
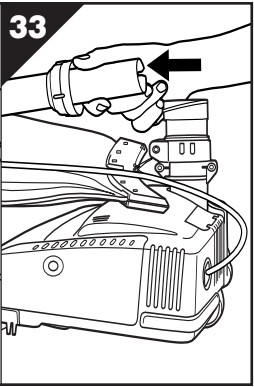
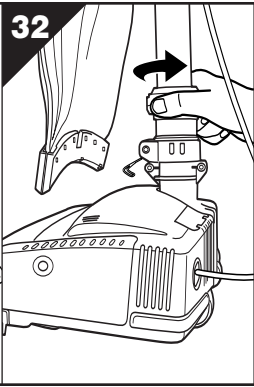
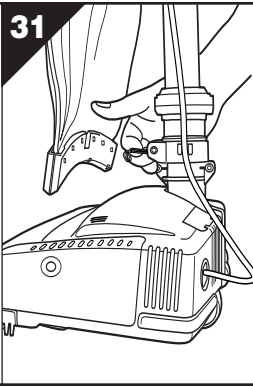
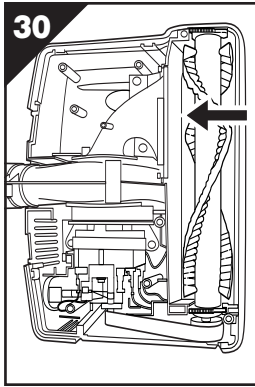
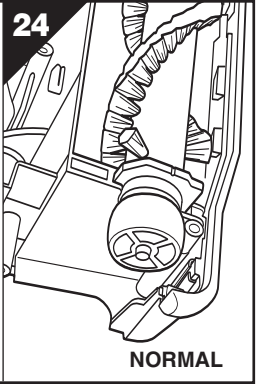
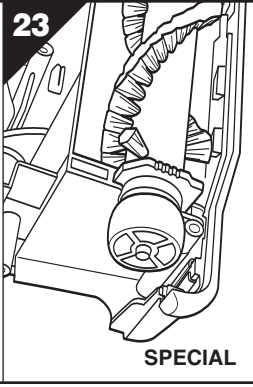
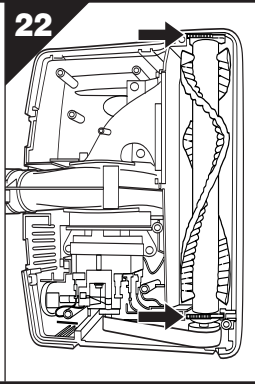
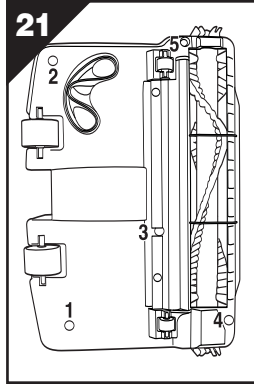
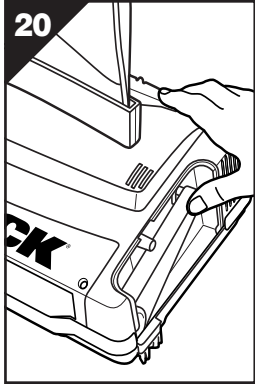
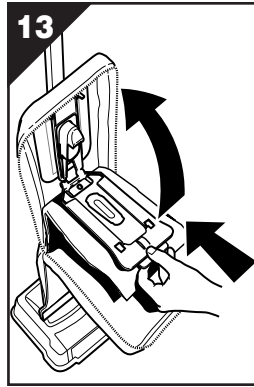
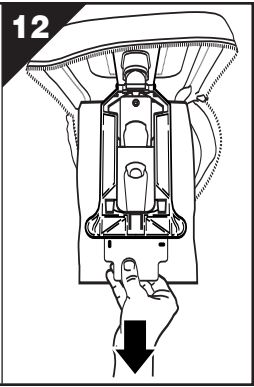
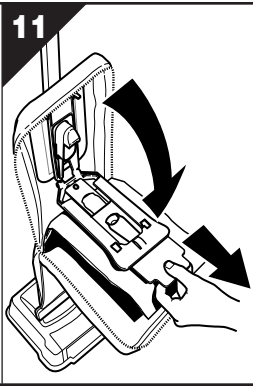
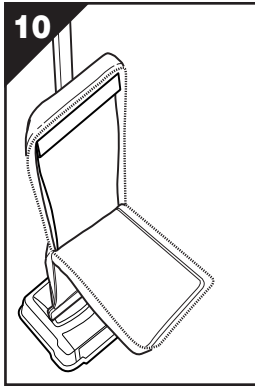
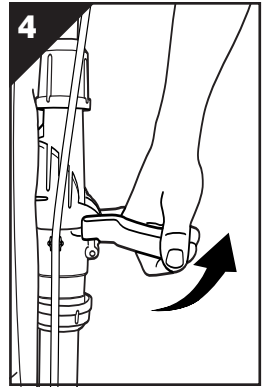
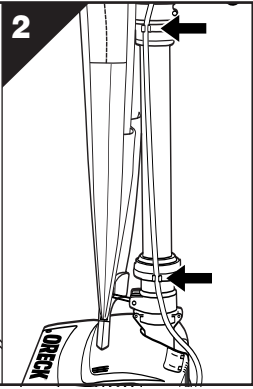
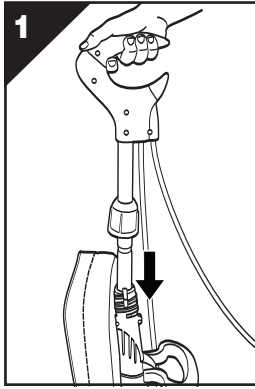

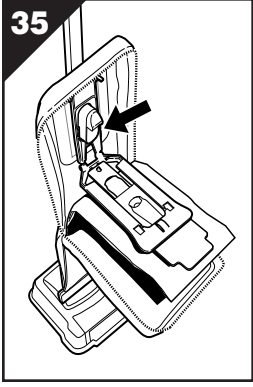
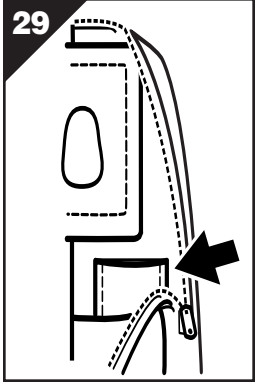
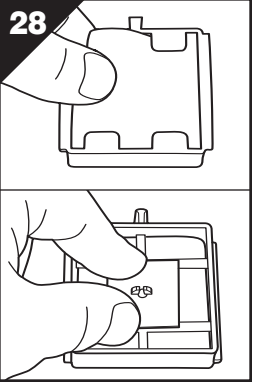
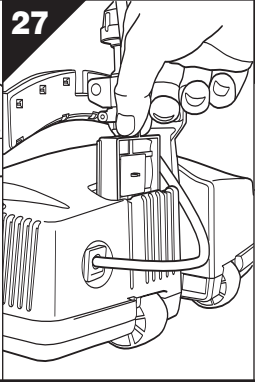
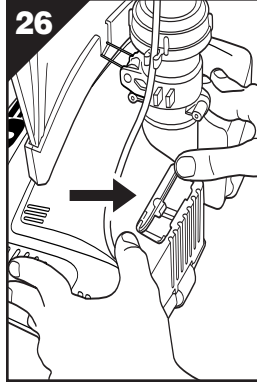
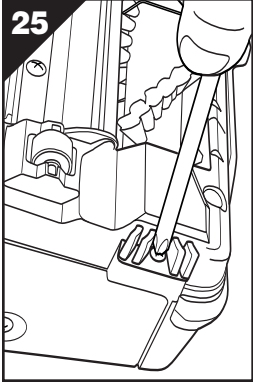
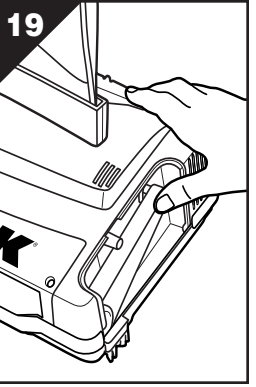
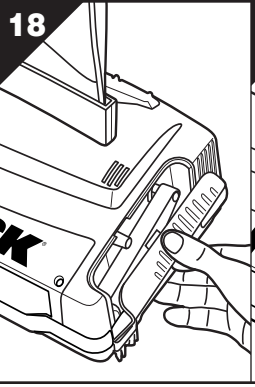
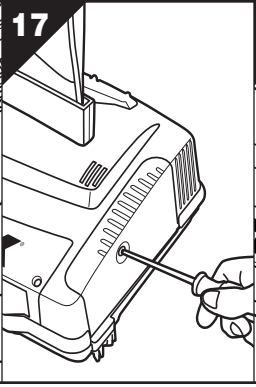
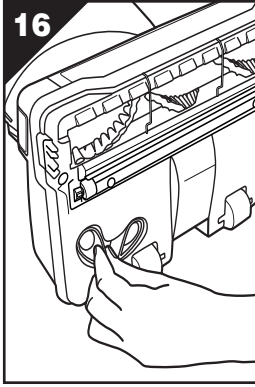
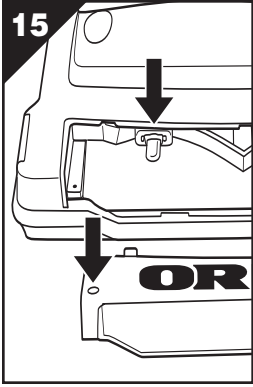
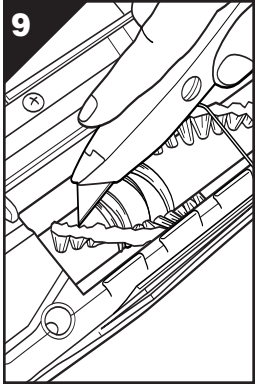
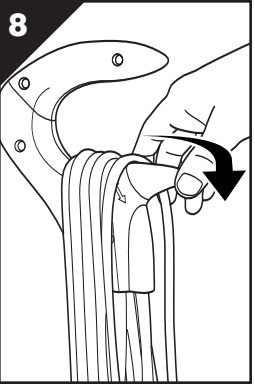
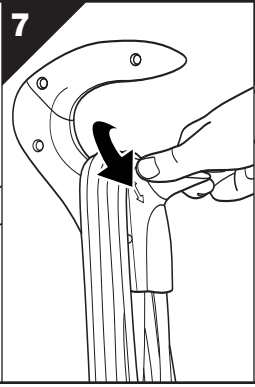
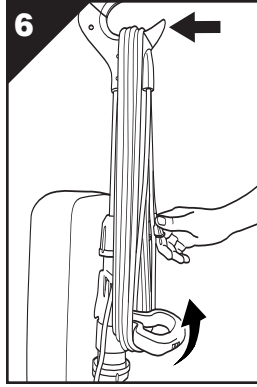
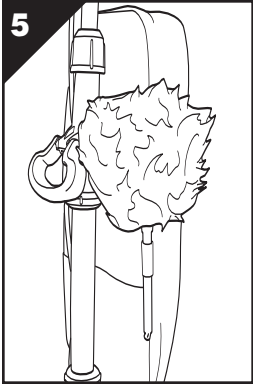

BEFORE OPERATING CLEANER, READ ALL INSTRUCTIONS IN THIS MANUAL CAREFULLY.

Table of Contents

Maintenance and Customer Service, Polarized Plug Notice, Accessories, Important Safety Instructions	page 3
Warranty, Troubleshooting Guide	page 4
Parts List, Assembly, Operating Instructions, General Information	page 5
General Information cont., To Replace Filter Dust Bag, Bulb Replacement, How to Replace a Worn Belt, To Adjust or Replace Brush	page 6
Edge Brush Replacement, Motor Filter and Oreck Fresh Air® Scent Cartridge Replacement, Using an Oreck Fresh Air® Tab, Stuffing or Blockage	page 7

Maintenance and Customer Service

Your Oreck vacuum cleaner is a product of precise engineering. The motor bearings are permanently lubricated and should not be oiled. If you require additional information or have problems with your Oreck appliance, you may call ORECK customer service at:

US: 1-800-989-3535 Canada: 1-888-676-7325

Please specify the model number and serial/code number which can be found on the data plate on the back of the vacuum.

Save your sales or purchase slip. Should your Oreck appliance require warranty service in the U.S.A., present this slip to the authorized service center as your proof of purchase date or, in Canada, call customer service.

Polarized Plug Notice

This product is equipped with a polarized alternating current line plug (a plug having one blade wider than the other). This plug will fit into the power outlet only one way. This is a safety feature. If you are unable to insert the plug fully into the outlet, try reversing the plug. If the plug should still fail to fit, contact an electrician to replace the obsolete outlet. Do not defeat the purpose of the polarized plug.

Accessories (Sold Separately)

ITEM	PART #
1. Dust Bag, 8 Pack, Saniseal® Hypo-Allergenic	CCPK8DW
2. Belts, 3 Pack	0300604
3. Fresh Air® Scent Cartridges	
Notes of Vanilla®, 8pk.	FA1PK
Spring Mullberries®, 8pk.	FA2PK
Blooming Jasmine®, 8pk.	FA3PK
4. Light Bulb	77051-01
5. Exhaust Filter, 4pk.	EF4PK
6. 24" Lambs Wool Duster	ORD24

IMPORTANT SAFETY INSTRUCTIONS

When using an electrical appliance, basic precautions should always be followed, including the following:

**READ ALL INSTRUCTIONS BEFORE
USING THIS VACUUM CLEANER**



WARNING

**To reduce the risk of fire,
electric shock, or injury:**

- Do not leave appliance unattended when plugged in. Unplug from outlet when not in use and before servicing.
- Do not use outdoors or on wet surfaces.
- Do not operate the unit while in the upright and locked position.
- Do not let the unit run while in any one stationary position for any period of time. Keep the unit moving while in operation.
- Do not allow to be used as a toy. Close attention is necessary when used by or near children.
- Use only as described in this manual. Use only manufacturer's recommended attachments.
- Do not use with damaged cord or plug. If appliance is not working as it should, has been dropped, damaged, left outdoors, or dropped into water, return it to a service center or call customer service at: **US: 1-800-989-3535 Canada: 1-888-676-7325.**
- Do not pull or carry by cord, use cord as a handle, close door on cord, or pull cord around sharp edges or corners. Keep cord away from heated surfaces.
- Do not run appliance over cord.
- Do not unplug by pulling on cord. To unplug, grasp the plug, not the cord.
- Do not handle plug or appliance with wet hands.
- Do not put any object into openings. Do not use with any opening blocked; keep free of dust, lint, hair and anything that may reduce air flow.
- Keep hair, loose clothing, fingers and all parts of body away from openings and moving parts.
- Do not use to pick up anything that is burning or smoking, such as cigarettes, matches, or hot ashes.
- Do not use without filter bag assembly in place.
- Turn off all controls before unplugging.
- Use extra care when cleaning on stairs.
- Do not use to pick up flammable or combustible liquids, such as gasoline or lighter fluid, or use in areas where they may be present.
- Do not use appliance in an enclosed space where flammable, explosive or toxic vapors are given off by oil base paint, paint thinner, some mothproofing substances, or in an area where flammable dust is present.
- Do not pick up toxic material such as chlorine bleach, drain cleaner, gasoline, etc. with this appliance.

SAVE THESE INSTRUCTIONS
Household Use Only

Warranty

ORECK MANUFACTURING COMPANY: (Oreck Manufacturing Company gives you the following limited warranty for this product only if it was originally purchased for residential use, not resale from Oreck or an Oreck Authorized Retail Dealer.)

Oreck will repair or replace, free of charge, to the original purchaser, any part that is found to be defective in material or workmanship within thirty (30) days of the date of manufacture. This limited warranty applies to normal domestic use. Any commercial use of this product will void this limited warranty.

This limited warranty does not cover the replacement of expendable or consumable parts such as belts, brushes, bulbs, disposable bags and other parts subject to normal wear unless they are defective in material or workmanship.

This limited warranty does not apply to any part subjected to accident, abuse, commercial use, alteration, misuse, damage caused by act of God, the use of voltages other than indicated on the serial number displayed on this product or service of this product by other than Oreck or a participating Factory Authorized Service Center.

Oreck does not authorize any person or representative to assume or grant any other warranty obligation with the sale of this product.

Oreck's limited warranty is valid only if you retain proof of purchase from Oreck or an Oreck Authorized Retail Dealer for this product. If you purchase this product from any other source, your purchase is "AS IS," which means Oreck grants you no warranty, and that you, not Oreck, assume the entire risk of the quality and performance of this product, including the entire cost of any necessary servicing or repairs of any defects.

Oreck's liability for damages to you for any costs whatsoever arising out of this statement of limited warranty shall be limited to the amount paid for this product at the time of original purchase, and Oreck shall not be liable for any direct, indirect, consequential or incidental damages arising out of the use or inability to use this product.

Some states do not allow the exclusion or limitation of incidental or consequential damages, so the above limitation or exclusion may not apply to you.

ALL EXPRESS AND IMPLIED WARRANTIES FOR THIS PRODUCT, INCLUDING IMPLIED WARRANTIES OF MERCHANTABILITY AND FITNESS FOR A PARTICULAR PURPOSE, ARE LIMITED IN DURATION TO THE WARRANTY PERIOD, AND NO WARRANTIES, WHETHER EXPRESS OR IMPLIED, WILL APPLY AFTER THIS PERIOD.

Some states do not allow limitations on the duration of implied warranties, so the above limitation may not apply to you.

This warranty gives you specific legal rights, and you may also have other rights which vary from state to state.

Troubleshooting Guide



WARNING: Unplug cord from electrical outlet before servicing.

SAVE SERVICE CALLS...CHECK THESE FIRST:

- Is the disposable filter dust bag full?
- Are pores of filter dust bag clogged with powder or fine dust?
- Is anything clogging the revolving brush, lower tube, intake opening, fan housing or connector assembly opening?
- Is the belt in place and turning the brush?
- Are the brush ends in the proper location?
- Does the brush turn freely? Are hair, string or rug fibers wound around the brush?

PROBLEM	POSSIBLE SOURCE	AREAS TO CHECK
CLEANER WILL NOT RUN	Not plugged in properly.	Be sure cleaner is firmly plugged into wall outlet.
	No electricity in wall outlet.	Check electrical source—fuse or circuit breaker.
CLEANER DOES NOT PICK UP	Filter bag is full.	Replace filter bag. See "To Install Paper Filter Dust Bag."
	Nozzle or intake pivot clogged.	Clear obstruction.
	Belt is broken or stretched.	Replace belt.
	Brush is worn.	Replace brush if bristles do not extend beyond baseplate.
	Bag tube clogged.	Clear obstruction.
	Bag pores are clogged with fine dust.	Change bag.
	Impeller fan is broken.	Return to Service Center for repair.
Revolving brush is not even at both ends.	Check bearing seal. Make sure words "normal" or "special" match at each end.	

ALL OTHER SERVICING SHOULD BE DONE BY AN ORECK AUTHORIZED SERVICE CENTER.

**CALL CUSTOMER SERVICE HOT LINE
US: 1-800-989-3535 Canada: 1-888-676-7325**

Whenever calling, please be sure to have your model and serial number from data plate.

Parts List

To assist you in identifying components of your vacuum, the parts have been numbered as follows:

- 1 Helping Hand® handle with soft grip
- 2 On/off switch
- 3 Cord dump
- 4 Handle tube
- 5 Bag stiffener
- 6 Deflector
- 7 Bag dock
- 8 Carry handle
- 9 Zipper
- 10 Bag clip
- 11 Headlight cover
- 12 Front light lens
- 13 Main bumper
- 14 Edge brush
- 15 Belt door
- 16 Power cord
- 17 Cord assembly
- 18 Handle collar
- 19 Connector assembly
- 20 Carry handle clamp
- 21 Collars
- 22 Lower tube
- 23 Bag clip clamp
- 24 Scent cartridge door
- 25 Fan housing
- 26 Rear wheels
- 27 Side light
- 28 Cover
- 29 Bag spring
- 30 Bag pocket
- 31 Outer bag
- 32 Power nozzle
- 33 Inner filter bag
- 34 Duster loop

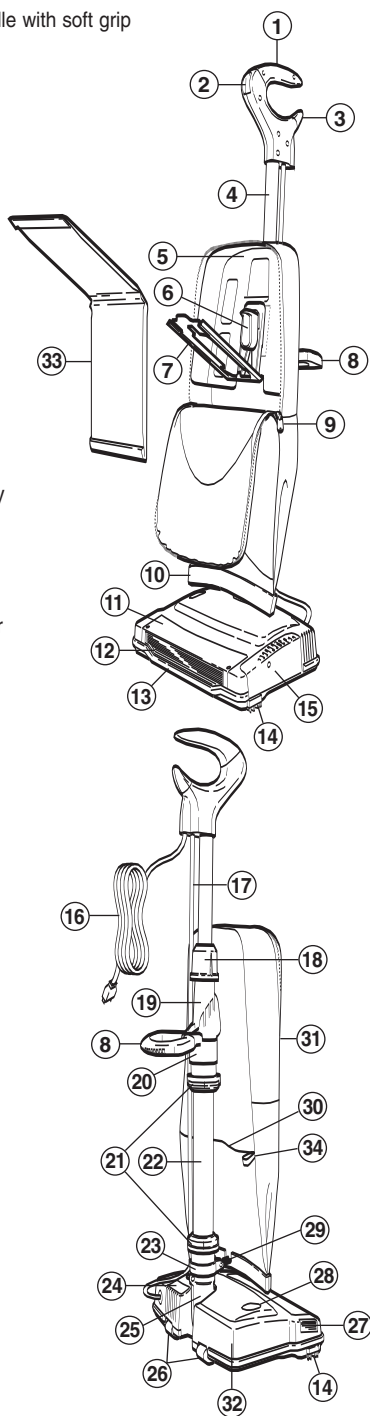

Assembly

- fig. 1** With ON/OFF switch facing the front of the unit, align slots in handle tube with tabs in connector. Insert the handle tube into connector. Tighten collar at base of handle tube onto the connector until it locks, “snaps”.
- fig. 2** Snap cord assembly into the cord clip located on the left side of the collar. Leave excess cord at the power head to allow movement.

Operating Instructions

Make sure disposable paper filter dust bag is in place. **DO NOT** operate the cleaner without a paper filter dust bag. Plug the power cord into an electrical outlet and press the **On Low (I) - On High (II) - OFF(O)** switch on handle assembly when ready to operate.

Up-Position Lock

fig. 3 Place foot on power head and lean handle back gently to release lock for vacuum use. Return handle to the full upright position to engage lock.

NOTE: Do not operate the unit while in the upright and locked position. Do not let the unit run while in any one stationary position for any period of time. Keep the unit moving while in operation.

Carry Handle

fig. 4 Raise the carry handle located on back of the unit for easy lifting, carrying, and stair vacuuming. Lower the handle during use to eliminate obstruction.

Duster Loop

fig. 5 For convenient use of dusters, a loop has been sewn onto the outer bag. This will allow easy removal and storage of the duster.

For Easy Power Cord Storage

fig. 6 Raise carrying handle and wrap power cord around carry handle and Helping Hand® handle.

fig. 7 To release cord, twist cord dump located on Helping Hand® handle 1/2 turn. Slide cord off handle. (**fig. 8**)

Cleaner Storage

Both the Helping Hand® handle and carry handle can be used for convenient, space saving storage of cleaner. Hang cleaner by carry handle on a sturdy fastener or Helping Hand® handle on a closet rod.

Operating Recommendations

This new ORECK XL21 High-Speed Upright is one of the finest, fastest, and strongest units in its class. You'll love the way it cleans, gets under things, and it's SO lightweight and easy to use.

The following are a few simple suggestions regarding its operation:

1. When inserting a new disposable paper filter dust bag—**FIRST PUFF OUT and OPEN THE BAG.**
2. When the disposable filter dust bag is full, **REPLACE IT.**
3. If at any time the machine does not pick up properly or makes an unusual noise, **STOP OPERATION** and service.
4. Although your upright will pick up pins, paper clips, and other small objects, it is recommended that these be removed from the floor before you vacuum. Failure to do so may result in permanent damage to the motor suction fan and its housing.
5. **WARNING:** Do not use your vacuum cleaner on damp or wet surfaces. This will cause damage to the vacuum cleaner and is dangerous to the user. Damage caused by use on wet or damp surfaces is not covered under warranty.
6. **REPLACE THE BELT EVERY 6 MONTHS, SCENT CARTRIDGE EVERY MONTH, AND MOTOR FILTER EVERY 2 MONTHS.**
7. Change the disposable filter dust bag at least once a month—even if it is not full! The collected dust in the dust bag can cause odor, attract moisture, and can affect the efficiency of the cleaner.
8. **DO NOT** run the vacuum cleaner over the cord. The revolving brush could damage the cord.

General Information

The performance of your new cleaner greatly depends upon care and maintenance. The instructions in this manual will guide you in performing basic care and maintenance. To obtain the most satisfying years of service read the instructions and keep them handy for future reference.

Disposable Paper Filter Dust Bags

Disposable paper filter dust bags play a very important role in the efficiency of your ORECK vacuum cleaner. The purpose of the filter bag is to trap dirt, but at the same time it must be porous enough to allow air to pass through. If the filter bag becomes clogged, no air can pass through the cleaner and cleaning cannot take place, regardless of the cleaner's power. Increase the CLEANING POWER of your cleaner by changing the bag at least once a month—even if it is not full!

DO NOT FILL ABOVE THE LINE INDICATED ON THE DUST BAG.

Be sure the disposable paper filter dust bag is installed properly.

All paper dust bags are not the same. Your ORECK disposable dust bags have been designed to be used with the ORECK cleaner. Using bags other than genuine ORECK disposable bags will affect the cleaning ability of your cleaner and could cause damage to it.

HEPA-Celoc® Hypo-Allergenic Filter System

The HEPA-Celoc outer bag of your vacuum cleaner is high filtration medical material designed to filter the smallest of dust particles. It is important the inside of the outer bag be cleaned. Hand wash the outer bag, turned inside out with warm water and air dry. If desired, the HEPA-Celoc outer bag can be replaced for renewed efficiency. The Celoc layered disposable inner dust bag must be replaced once a month even if it is **not** full. Change it more often if it is used in extremely dirty areas.

The Belt

The belt on your vacuum cleaner controls the speed of the revolving brush and is very important for the effective operation of the cleaner. If the belt becomes stretched or cut, it will cause the revolving brush to stop completely or slow down. See instructions in the manual for replacing belt.

An extra belt is stored in the baseplate of your cleaner. When buying replacement belts, use ONLY ORECK genuine belts. Belts other than Oreck belts will not operate the revolving brush correctly and may create undue stress which will cause damage to the motor and brush bearings. Using belts other than ORECK belts will void the warranty.

Motor Filter

The motor filter is used to filter tiny particles released by the motor exhaust while in operation. The motor filter is not necessary for operation but is helpful in removing contaminants from the air.

NOTE: Motor filter should be replaced every two months for best performance.

Oreck Fresh Air® Cartridges

An Oreck Fresh Air® Cartridge adds a desired fragrance to the air while vacuuming. It is placed behind the motor filter and uses heat and air generated from the motor to spread the fragrance.

NOTE: Cartridge should be replaced every month when filter dust bag is replaced or as desired.

Lubrication

The vacuum cleaner motor bearings are factory lubricated and sealed. Further lubrication is not required.

General Cleaner Care

fig. 9 At least once a month, check for and remove excessive lint, string or hair from revolving brush. Patented cleaning grooves on brush roll will allow easier cleaning.

Wipe the outside of the cleaner with a damp cloth. Also clean the connector deflector assembly area, base of cleaner and fan housing area. If there is dust in the outer bag, vacuum it or shake it out.

A little preventative maintenance will keep your cleaner looking new and will ensure continued cleaning effectiveness.

CAUTION—Wood Floors, Soft (Vinyl, Asphalt Tile, etc.) Floor Surfaces and Polished Floor Finishes

Use floor and floor finish manufacturer's recommended methods of cleaning. The roller brush may also scuff very soft finishes. Do not operate the unit while in the upright and locked position. Do not let the unit run while in any one stationary position for any period of time. Keep the unit moving while in operation.

To Replace Filter Dust Bag



WARNING: Unplug cord from electrical outlet before servicing.

BAG REMOVAL:

fig. 10 Unzip outer bag completely.

fig. 11 Pull bag cardboard collar to release bag dock door from connector. Bag dock door will hinge downward.

fig. 12 Gently pull bag cardboard collar upward out of the bag dock. Saniseal® dust seal will close automatically.

BAG INSTALLATION:

fig. 13 Slide the cardboard collar completely onto bag dock door.

fig. 14 Firmly push bag dock door with both thumbs on indication point until it snaps.

Bulb Replacement



WARNING: Unplug cord from electrical outlet before servicing.

fig. 15 Remove lamp housing by removing two (2) screws in the top of the lamp housing. Pull burned out bulb from holder and replace with new bulb. Replace lamp housing by replacing two screws in the top of the lamp housing.

How to Replace a Worn Belt



WARNING: Unplug cord from electrical outlet before servicing.

fig. 16 Remove the replacement belt from the storage channel.

fig. 17 Remove the door by removing the hold down screw located on side of power head.

fig. 18 Fold door away from the power head and lift it away.

fig. 19 Remove the belt from the motor drive shaft and brush roll pulley.

fig. 20 Loop the new belt over the brush roll pulley. Place the opposite end of the belt on the motor drive shaft.

fig. 18 Replace the door by placing the bottom tab on door into slots located inside power head and pressing the door closed.

fig. 17 Replace the hold down screw and tighten.

To Adjust or Replace Brush



WARNING: Unplug cord from electrical outlet before servicing.

Your Oreck Vacuum comes with the brush roll set at the **NORMAL** position for most types of carpets. When using vacuum primarily on Berber Carpets, adjust brush roll to the **SPECIAL** setting.

fig. 21 Remove the baseplate by removing 5 screws. Then, remove the belt and brush roll from the housing.

fig. 22 Rotate both end cards of the brush roll to show "**SPECIAL**" and replace in the holding channels of the housing.

fig. 23 **NOTE:** The one marked "**SPECIAL**" has **several ribs** on top of the end card.

fig. 24 The brush end card setting marked "**NORMAL**" has **one rib**. When rotating bearings, make sure both end card assembly settings are the same and face up when replacing the brush roll. Reassemble the belt and the baseplate.

Edge Brush Replacement



WARNING: Unplug cord from electrical outlet before servicing.

fig. 25 Turn the power head over. With baseplate facing up, remove the screw located in the center of each edge brush. Remove both edge brushes and replace with new ones. Replace both screws and tighten.

Motor Filter and Oreck Fresh Air® Scent Cartridge Replacement



WARNING: Unplug cord from electrical outlet before servicing.

The Motor Filter located at the back of the power head should be replaced **every 2 months**. The Scent Disk should be replaced **every month** when changing the inner filter bag.

fig. 26 Press two locking tabs on cartridge cover and remove the cover.

fig. 27 Remove the cartridge holder by lifting on tab at top of holder.

fig. 28 Remove old filter or scent disk from holder. Replace filter or scent disk and reinsert holder.

Replace cover by aligning tabs on cover with slots in housing and pressing the cover in place until cover tabs lock.

Using an Oreck Fresh Air® Tab

fig. 29 Your ORECK XL21 vacuum cleaner has a special ORECK FRESH AIR® tab pocket. This light-colored pocket is located inside the vinyl bag in the area where the paper disposable bag attaches to the intake tube. Insert tablet in pocket if desired.

Stuffing or Blockage

IMPORTANT: On plush and new carpets, stuffing may occur inside the intake tube and the lower tube assembly. This is due to excessive fuzz and loose cuttings in the carpet. Stuffing could occur for the first few cleanings until all the loose material is removed. Due to the high efficiency of the cleaner, many older carpets will cause stuffing when the cleaner is first used on them. If your vacuum cleaner does not pick up properly, or makes unusual noise and the outer bag does not fluff up or balloon open, follow these steps:



WARNING: Unplug cord from electrical outlet before servicing.

fig. 30 Check for blockage at the mouth of the intake opening. If there is blockage, remove it with long-nose pliers, a screwdriver or coat hanger. If you can not reach the blockage, remove baseplate. (**fig. 21**)

fig. 31 If the blockage is not at the base, remove lower tube. Unhook retainer spring, releasing bottom of bag.

fig. 32 Twist lower collar counterclockwise to slide up. Pull tube out of base.

fig. 33 Check for blockage. If blockage is in the tube, remove with a coat hanger.

fig. 34 If tube is not blocked, look into fan housing. Remove debris with long-nose pliers, a screwdriver or coat hanger.

fig. 32 To reassemble, check O-ring on tube, and replace if damaged. Replace tube by first lining up slot at base of tube with tab inside fan housing. Insert tube and push down until the tube is seated. Make sure O-ring is in place against fan housing opening. Replace and tighten collar until collar locking tabs are locked in place. Reattach bag spring (**fig. 31**)

fig. 35 Many times blockage occurs due to a full dust bag causing dirt to back down the air flow system. When that happens, the blockage will be at the top of the system, starting in the area where the dust bag connects to the connector assembly.

NOTE: If the above actions do not correct the problem, contact an Oreck authorized service center or call the customer service center.
US: 1-800-989-3535 Canada: 1-888-676-7325